



K38-M7113-B03
PICK-UP NOZZLE B
YAMA



K38-M7113-C00
PICK-UP NOZZLE C
YAMA



K38-M7113-D01
PICK-UP NOZZLE D
YAMA

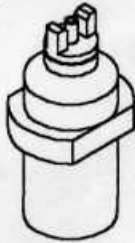

GLUE GAP = 0.15
K37-M7113-102
DISPENSING NOZZLE
(ID = 00.5, 1 DOT)
YAMA

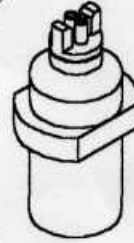

GLUE GAP = 0.1
PITCH = 1.0
(SPECIAL REQUEST)
K37-M7113-102(2)
(AVI)
DISPENSING NOZZLE
(ID = 00.5, 2 DOTS)
YAMA



PICK-UP NOZZLE Ø3.0
(ID = Ø2.0, OD = Ø3.0)
(PRECISION HEAD)
YAMA



PICK-UP NOZZLE Ø5.0
(ID = Ø4.0, OD = Ø5.0)
(PRECISION HEAD)
YAMA



PICK-UP NOZZLE Ø7.5
(ID = Ø6.0, OD = Ø7.5)
(PRECISION HEAD)
YAMA

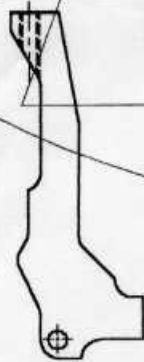

K38-M7111-101
ARM 3
YAMA

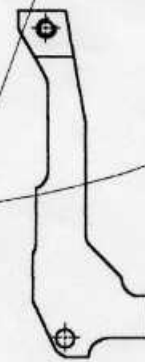

K38-M7112-102
ARM 4
YAMA

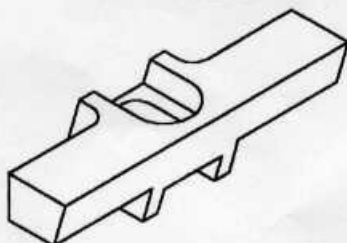

K38-M7167-701
JAW SO-20 (TYPE 8)
YAMA

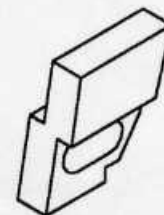

K38-M7167-601
JAW SO-02 (TYPE 8)
YAMA

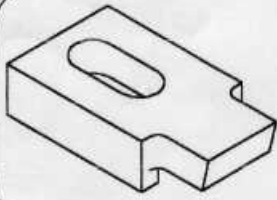

K38-M7167-COO
JAWS 4011Y (TYPE 2.4)
YAMA

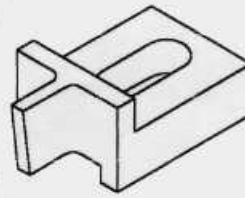

K38-M7167-B01
JAW 0711Y (TYPE 2.4)
YAMA

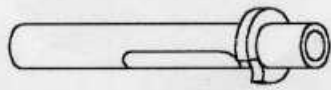

KH-M7113-COO
PICK-UP NOZZLE (TYPE 8)
YAMA, MK-II

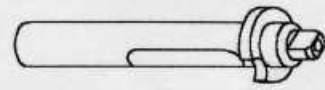

KH-M7113-B00
PICK-UP NOZZLE (TYPE 2)
YAMA, MK-II

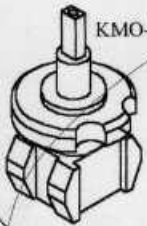

KMO-M711A-02X(2)[W/O-SPRING]
KMO-M711A-02X[W-SPRING]
PICK-UP NOZZLE A
(TYPE 31)
YAMA, YVL88

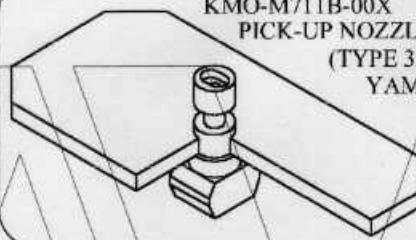

KMO-M711B-00X
PICK-UP NOZZLE B, COMP
(TYPE 32-1)
YAMA, YVL88

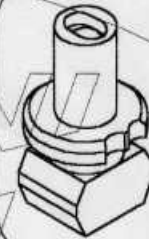

KMO-M711C-00X
PICK-UP NOZZLE C
(TYPE 32-2)
YAMA, YVL88



(KG7-M711D-C0X)
PICK-UP NOZZLE D, COMP
(TYPE 33)
YAMA, YVL88
(KMO-M711D-00X)

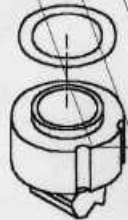

(KG7-M711E-C0X)
PICK-UP NOZZLE E, COMP
(TYPE 34)
YAMA, YVL88
(KMO-M711E-00X)

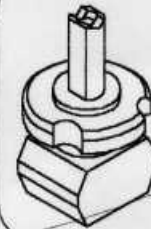

TYPE 35 MELF NOZZLE
[KG7-M71AB-AOX]
[KMO-M71AB]
(TYPE 35 MELF), YAMA

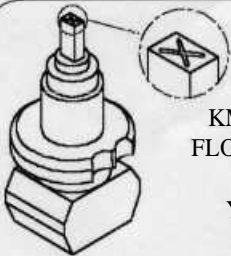

KMO-M711A-302
FLOATING NOZZLE
(TYPE 31)
YAMA, YV100



KG9-M7113-100
NOZZLE S, COMP
(VISION HEAD)
YAMA, YM51VMII



KG9-M7113-200
NOZZLE M
(VISION HEAD)
YAMA, YM51VMII

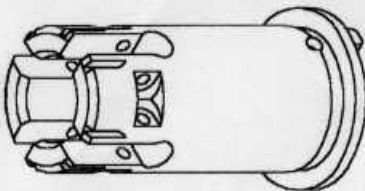

K38-M7102-001
SHAFT,
CHUCK HOLD
YAMA

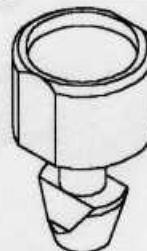

KG9-M7113-300
NOZZLE L
(VISION HEAD)
YAMA, YM51VMII

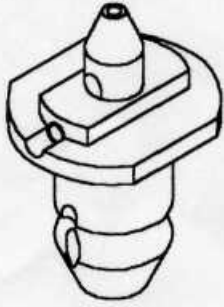

KH4-M71N1-00
PICK-UP NOZZLE
(TYPE 21)
YAMA, YV120

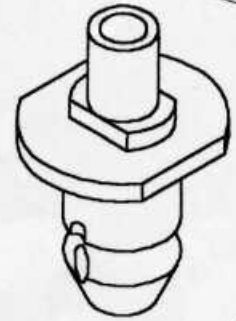

KH4-M71N2-00
PICK-UP NOZZLE
(TYPE 22)
YAMA, YV120

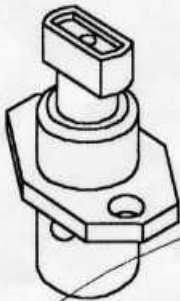

KV8-M71N3-A01
(YV88 & YV100X)
NOZZLE 73F



KV8-M71D6-F02
SHAFT NOZZLE

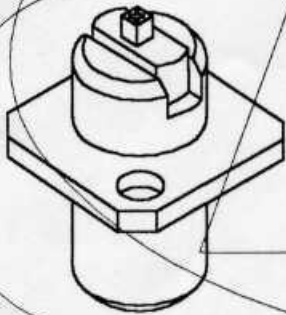

KV8-M71N1-A01
(YV88 & YV100X)
NOZZLE 71F

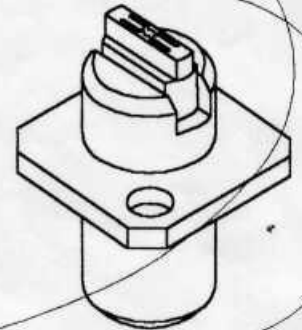

KV8-M71N2-A01
(YV88 & YV100X)
NOZZLE 72F

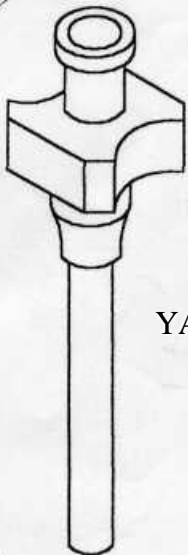

K42-M7511-OOX
NEEDLE
YAMAHA, YV100D

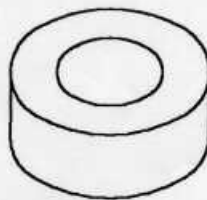

K40-M7133-OOX
DAMPER 3
YAMAHA

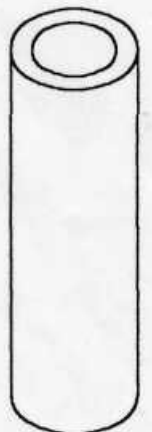

KG3-M7191-OOX
SPACER
YAMAHA

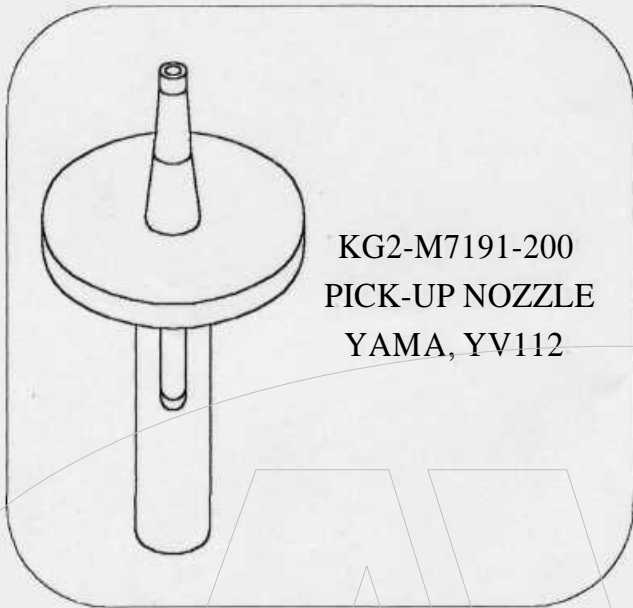

KG2-M7191-200
PICK-UP NOZZLE
YAMA, YV112

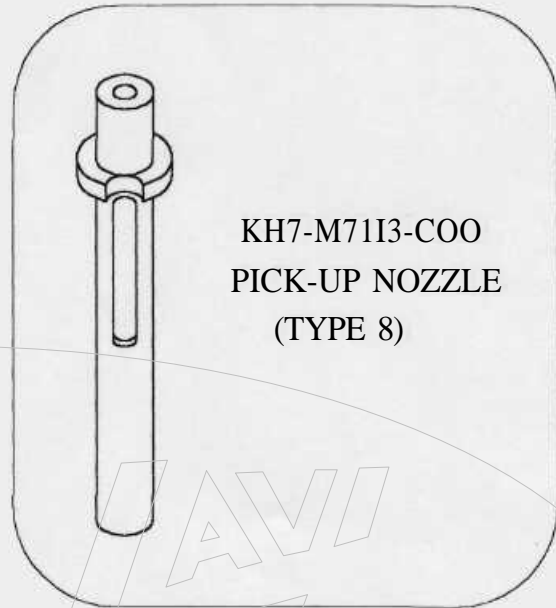

KH7-M7113-COO
PICK-UP NOZZLE
(TYPE 8)

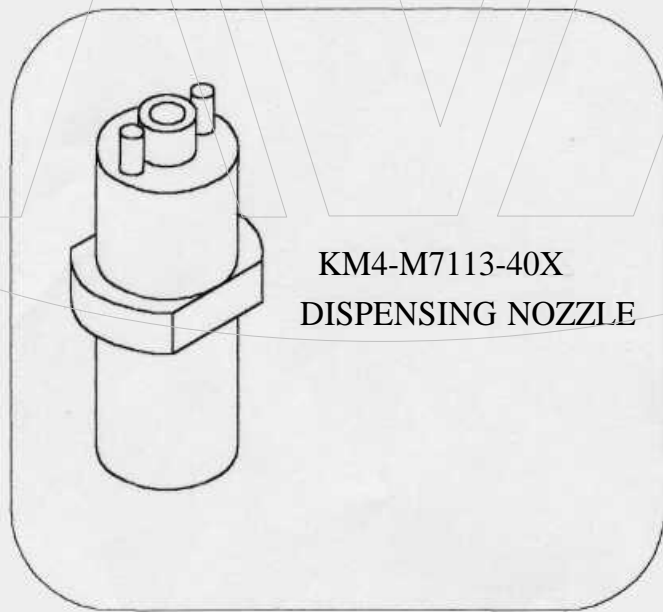

KM4-M7113-40X
DISPENSING NOZZLE